

LEGENDA

- Saluran air
- Jalan
- Kereta Api
- Sungai
- Batas Desa
- Rumah
- Pagar
- Bendungan
- Jembatan
- Sumbu
- Tiang Listrik
- Tanaman



Keterangan :
 - Ikatan Koordinat dan Elevasi (X,Y,Z) diambil dari BM.PASUT
 (BM.PASUT X = +355.508,270 Y = +9.241.690,980 Z = +0,936)



PEMERINTAH PROVINSI JAWA TENGAH DINAS PERENCANAAN DAN BANGUNAN DAERAH DAN KONTROL MUTU (DIPROV)		DIREKSI BINA WILAYAH DAN BINA MASYARAKAT (DIPROV)	
PETA IKHTISAR SUNGAI KUPANG, SUNGAI BANGER CS			
NO. SKALA	NO. PROJEKSI	NO. GAMBAR	NO. PERENCANAAN
10.000	UTM	10	10
TANGGAL 10/01/2018		DESA ...	

CP 01
 X 353.880.001
 Y 8.253.364.987
 Z +0,982

CP 02
 X 353.826.930
 Y 8.253.450.203
 Z +0,526

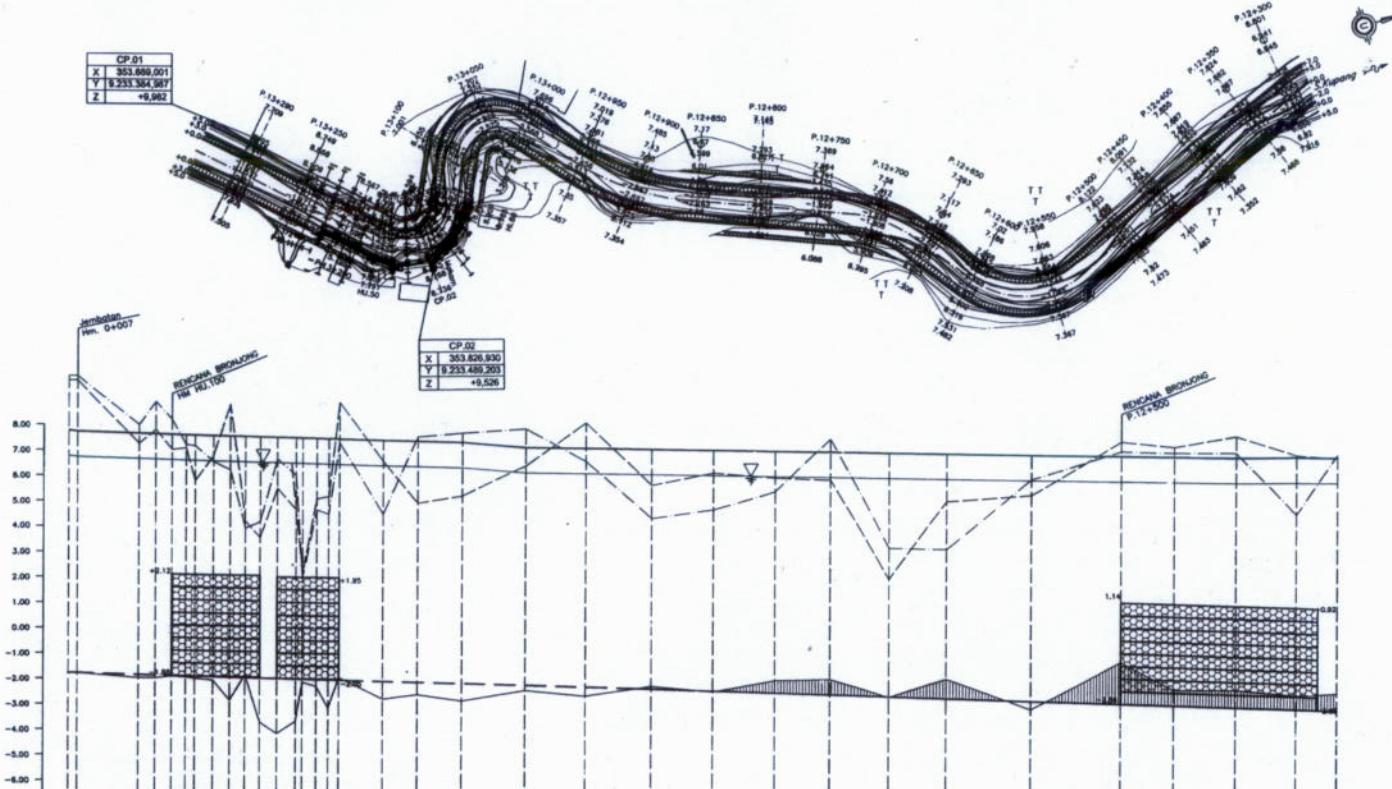

NO. PATOK		P.12+200	P.12+250	P.12+300	P.12+350	P.12+400	P.12+450	P.12+500	P.12+550	P.12+600	P.12+650	P.12+700	P.12+750	P.12+800	P.12+850	P.12+900	P.12+950	P.13+000
YANG ADA	JARAK PROFIL	48	51	54	57	60	63	66	69	72	75	78	81	84	87	90	93	96
	JARAK LANGSUNG	48	51	54	57	60	63	66	69	72	75	78	81	84	87	90	93	96
	ELEVASI TANGGUL KIRI	2.00	2.00	2.00	2.00	2.00	2.00	2.00	2.00	2.00	2.00	2.00	2.00	2.00	2.00	2.00	2.00	2.00
	ELEVASI TANGGUL KANAN	2.00	2.00	2.00	2.00	2.00	2.00	2.00	2.00	2.00	2.00	2.00	2.00	2.00	2.00	2.00	2.00	2.00
	ELEVASI DASAR SUNGAI	-1.70	-1.67	-1.64	-1.61	-1.58	-1.55	-1.52	-1.49	-1.46	-1.43	-1.40	-1.37	-1.34	-1.31	-1.28	-1.25	-1.22
RENCANA	ELEVASI TANGGUL	2.00	2.00	2.00	2.00	2.00	2.00	2.00	2.00	2.00	2.00	2.00	2.00	2.00	2.00	2.00	2.00	2.00
	ELEVASI MUKA AIR MAX.	2.00	2.00	2.00	2.00	2.00	2.00	2.00	2.00	2.00	2.00	2.00	2.00	2.00	2.00	2.00	2.00	2.00
	ELEVASI DASAR SUNGAI	-1.70	-1.67	-1.64	-1.61	-1.58	-1.55	-1.52	-1.49	-1.46	-1.43	-1.40	-1.37	-1.34	-1.31	-1.28	-1.25	-1.22
	SENDERAN KIRI																	
	SENDERAN KANAN																	
DIMENSI SUNGAI DAN DATA TANGGAHAN		Q = 815.84m ³ /s b=25m h=8.59 i=0.0013 V=3.46m/s																
		Q = 815.84m ³ /s b=25m h=8.87 i=0.0013 V=2.35m/s																

- LEGENDA
- Bench Mark
 - Control Point
 - Poles
 - Jalon
 - Sunter
 - Kontrol Interval TM
 - Elevasi
 - Kampang
 - Gerang-gerang
 - Jembatan
 - Sawah
 - Tegapan
 - Tombak
 - Bronjong

Keterangan :
 - Ikatun Koordinat dan Elevasi (X,Y,Z) diambil dari BM.PASUT
 (BM.PASUT X = +355.509,270 Y = +9.241.690,980 Z = +0,936)

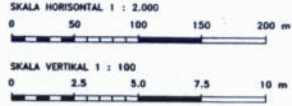

PEMERINTAH PROVINSI JAWA TENGAH
 DINAS PERENCANAAN SUMBER DAYA AIR DAN PENATAAN RUANG
 A. MENDIRI BUKAN KEMENTERIAN, P. JAWA TENGAH, SURABAYA, 60132
 SURABAYA (KODE POS: 60132)

GAMBAR :
PETA SITUASI DAN POTONGAN MEMANJANG SUNGAI KUPANG P.13+297 - P.12+300

NO. REGISTER : 01-02-07-08
 NO. LEMBAR : 02 / 004
 TANGGAL : 08 MRS 2018
 NOMBOR KONTRAK : 044 / 2018

DIREKTUR : POKER TALPIL ANJAL, ST
 WETUVA TMS
 SUKRI SANDORA, MT

DIREKTOR / KASUB : K. SUWANDI, MT
 KASUB PPT : I. LUKITO, Sp.1

YANG DREVER : OLEH : DWIPENC, DWET. DIREKTOR : DWIPENC, DWET.

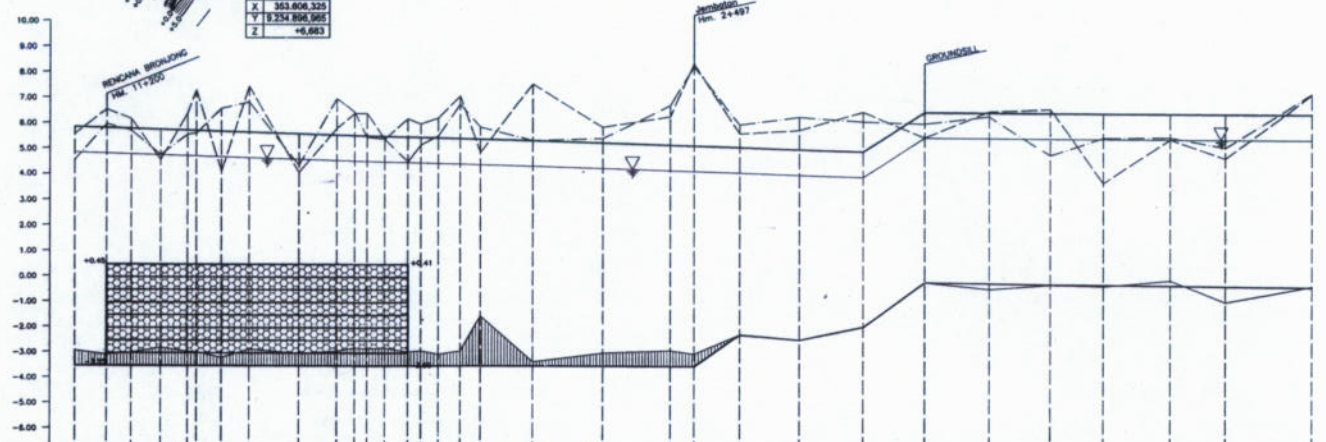
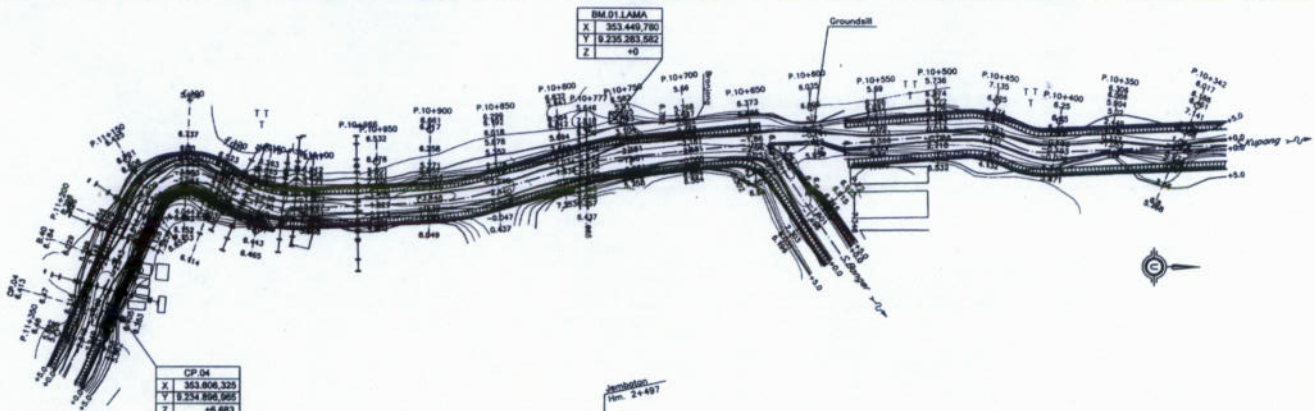

NO. PATOK

	P.11+350	A.20	A.40	A.80	P.11+200	E.100	P.11+050	P.110	P.100	P.10+950	P.10+900	P.10+850	P.10+800	P.10+750	P.10+700	P.10+650	P.10+600	P.10+550	P.10+500	P.10+450	P.10+400	P.10+350	P.10+342
JARAK PROFIL	20	20	20	20	20	20	20	20	20	20	20	20	20	20	20	20	20	20	20	20	20	20	20
JARAK LANGSUNG	20	20	20	20	20	20	20	20	20	20	20	20	20	20	20	20	20	20	20	20	20	20	20
ELEVASI TANGGUL KIRI	4.542	4.542	4.542	4.542	4.542	4.542	4.542	4.542	4.542	4.542	4.542	4.542	4.542	4.542	4.542	4.542	4.542	4.542	4.542	4.542	4.542	4.542	4.542
ELEVASI TANGGUL KANAN	4.542	4.542	4.542	4.542	4.542	4.542	4.542	4.542	4.542	4.542	4.542	4.542	4.542	4.542	4.542	4.542	4.542	4.542	4.542	4.542	4.542	4.542	4.542
ELEVASI DASAR SUNGAI	4.542	4.542	4.542	4.542	4.542	4.542	4.542	4.542	4.542	4.542	4.542	4.542	4.542	4.542	4.542	4.542	4.542	4.542	4.542	4.542	4.542	4.542	4.542
ELEVASI TANAH ASLI	4.542	4.542	4.542	4.542	4.542	4.542	4.542	4.542	4.542	4.542	4.542	4.542	4.542	4.542	4.542	4.542	4.542	4.542	4.542	4.542	4.542	4.542	4.542
ELEVASI TANGGUL	4.542	4.542	4.542	4.542	4.542	4.542	4.542	4.542	4.542	4.542	4.542	4.542	4.542	4.542	4.542	4.542	4.542	4.542	4.542	4.542	4.542	4.542	4.542
ELEVASI MUKA AIR MAX.	4.542	4.542	4.542	4.542	4.542	4.542	4.542	4.542	4.542	4.542	4.542	4.542	4.542	4.542	4.542	4.542	4.542	4.542	4.542	4.542	4.542	4.542	4.542
ELEVASI DASAR SUNGAI	4.542	4.542	4.542	4.542	4.542	4.542	4.542	4.542	4.542	4.542	4.542	4.542	4.542	4.542	4.542	4.542	4.542	4.542	4.542	4.542	4.542	4.542	4.542
SENDERAN KIRI																							
SENDERAN KANAN																							
DIMENSI SUNGAI																							
DAFTAR DATA TAMBAHAN																							

Q = 815.84m³/s b = 25m h = 8.27 i = 0.000162 V = 2.78m/s

Q = 244.75m³/s b = 20m h = 3.06 i = 0.00080 V = 1.92m/s

- LEGENDA**
- Bench Mark
 - Control Point
 - Pitak
 - Jalan
 - Jalan Tanah
 - Sungai
 - Kontur Interval 1M
 - Elevasi
 - Kampung
 - Gorong-gorong
 - Jembatan
 - Sewah
 - Tegalan
 - Tambak
 - Brongjing

Keterangan :
 - Iktan Koordinat dan Elevasi (X,Y,Z) diambil dari BM.PASUT
 (BM.PASUT X = +355.509,270 Y = +9.241.690,980 Z = +0,936)

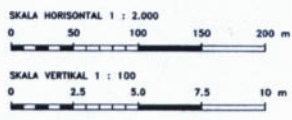

PEMERINTAH PROVINSI JAWA TENGAH
 DINAS PERENCANAAN, SUMBER DAYA AIR DAN PEMANTAUAN LINGKUNGAN & WILAYAH BUDIDAYA PERUMAH TANGGAH, PERUMAH TANGGAH, PERUMAH TANGGAH, PERUMAH TANGGAH (KODE POS : 50144)

REKOR SURVEI INVESTIGASI DAN DESAIN
 BERANGKUTAN PERENCANAAN DAN DESAIN

PEKERJAAN :
 SURVEI SITUASI DAN POTONGAN SUNGAI KUPANG
 (PASET P. 22)

NO. REGISTER : 01-08-01-07
 NO. LEMBAR : 07 / 804
 TANGGAL :
 NOMOR KONTRAK :
 08 MEI 2018 014 / 2018

DIREKTUR :
 DEWISYALDI, S.T., M.P., Ph.D.
 NIP. 195301011973001001

DEWISYALDI, S.T., M.P., Ph.D.
 NIP. 195301011973001001

DEWISYALDI, S.T., M.P., Ph.D.
 NIP. 195301011973001001

NO.	TGL.	YANG DREVISI	OLEH	DREVISI	DIKET.

Gal. tanah	110.30 M ³
Timb. tanah	- M ³

BID. PERSAMAAN														
ELEVASI	7.787	7.564	7.489	7.404	7.308	7.198	7.083	6.963	6.838	6.708	6.573	6.434	6.291	6.144
JARAK	8.00	5.00	5.20	3.01	2.23	3.74	5.00	4.09	5.00	1.91	0.853	2.835	6.13	2.89

HU.100

Gal. tanah	94.83 M ³
Timb. tanah	- M ³

BID. PERSAMAAN														
ELEVASI	8.493	8.333	8.230	8.170	8.098	8.013	7.923	7.828	7.728	7.623	7.513	7.403	7.293	7.183
JARAK	10.00	2.54	2.83	3.72	3.77	2.86	6.00	7.69	6.00	3.87	7.78	5.04	10.89	7.90

HU.90

Gal. tanah	96.52 M ³
Timb. tanah	- M ³

BID. PERSAMAAN														
ELEVASI	8.587	8.414	8.311	8.244	8.169	8.084	7.994	7.904	7.814	7.724	7.634	7.544	7.454	7.364
JARAK	10.80	1.40	1.80	3.30	1.80	7.20	5.50	5.84	5.50	1.99	3.58	5.42	5.40	5.40

P.13+200

Gal. tanah	109.25 M ³
Timb. tanah	- M ³

BID. PERSAMAAN														
ELEVASI	8.338	8.180	8.110	8.024	7.931	7.838	7.745	7.652	7.559	7.466	7.373	7.280	7.187	7.094
JARAK	9.94	3.00	6.80	2.78	4.94	2.04	5.00	3.90	5.00	2.19	3.85	7.00	4.01	2.56

HU.70



SKALA 1 : 200

	PEMERINTAH PROVINSI JAWA TENGAH DINAS PERENCANAAN, URURAN BANGUNAN, DAFTAR AIR DAN PENATAAN RUANG <small>J. WONGSOREJO BLOK AA-BB TELUR (DESA TERESA), TUGAS, KEC. PUSAT, KAB. WONOREJO (KODE POS: 50144)</small>		SEKSI SURVEI, INVESTIGASI DAN DESAIN BIDANG PERENCANAAN DAN BUKTI		
	GAMBAR : POTONGAN MELINTANG SUNGAI KUPANG HU.100 - HU.70		PERENCANAAN : DR. BUNDA SUPANG, BUNDA BANIKER CA KABUPATEN PESAWARAN PANGEST P-30 KADIBUKTI : PERALOKAN NO. REKAMER : 01-60-07-01 NO. JALAN LEMBAR : 21 / 204		
DIREKTUR : KETUA TIM : DIREKSI / KASUBID : MANAJEMEN : MANAJEMEN :		FOCUS TIM/PK ANDAR, ET S. SUKRI SANTANA, MT S. LUKITO, S.T S. LUKITO, S.T		TANGGAL : 08 SEP 2016 NOMOR KONTRAK : 014 / 2016	

NO.	TGL.	YANG DREVISI	OLEH	DIREKSI	DIREKSI	DIREKTUR

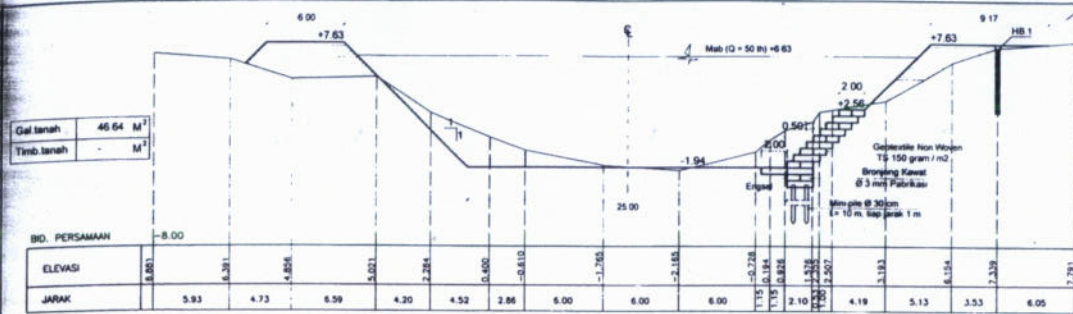

HU.50

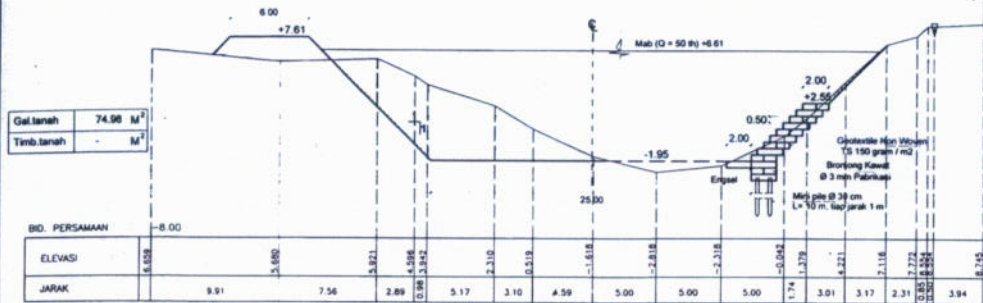

HU.32

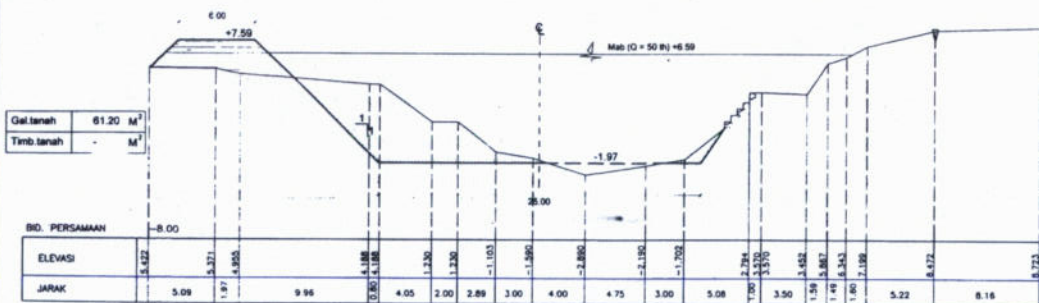

HU.20

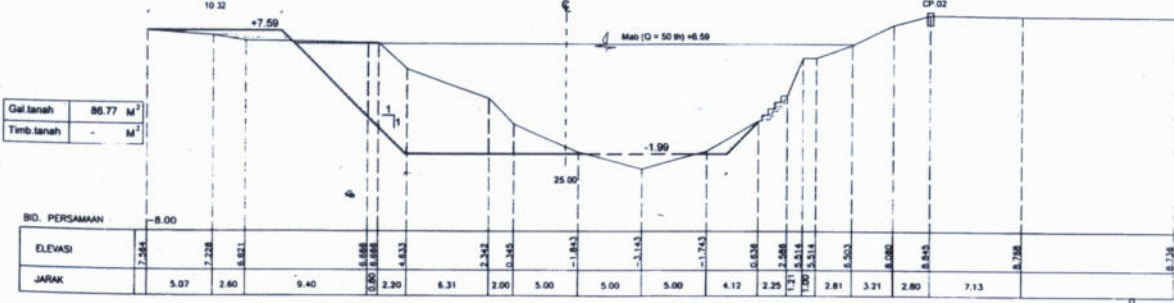

CP.02

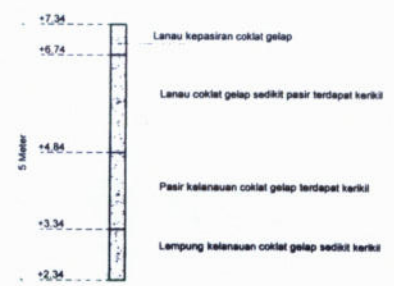

DETAIL HB.1
HU.50

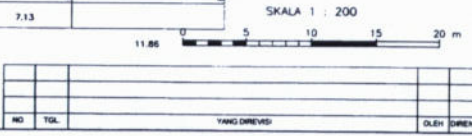

PEMERINTAH PROVINSI JAWA TENGAH DINAS PEKERJAAN UMUM, BUMBUH DAYA DAN PERENCANAAN RUANG J. WOLUPOLO BLOK AA-08 TELP. (081) 7982111 FAX. (081) 7982111 SURABAYA - KODE POS 60134		SEKSI SURVEI, INVESTIGASI DAN DESAIN BINAAN PERENCANAAN DAN BINAAN
GAMBAR POTONGAN MELINTANG SUNGAI KUPANG HU.50 - CP.02	PEKERJAAN DR. SUNGAI KUPANG, SUNGAI BANGER CE KABUPATEN PANGKALAN (PAGET P. 20)	
NO. REGISTER 01-00-07-02	NO. JML. LEMBAR 22 / 30	TANGGAL 08 MEI 2018
DIREKTUR MOEDJALIF AHMAD, ST KETUA TIM SUDJANTO, MT	DIREKSI / KASUBID. 4 BANGUNAN, NT KASUBID. 4.1 LAMOTO, Sp.1	NO. MONTIRAK 014 / 2018

Gal.tanah 76.34 M³
Timb.tanah 14.00 M³

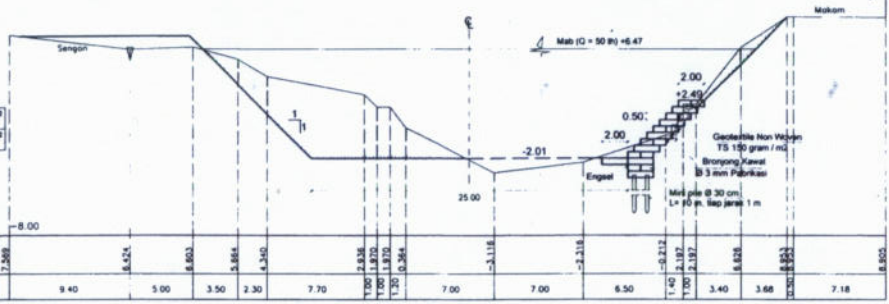

HI.20

Gal.tanah 82.76 M³
Timb.tanah M³

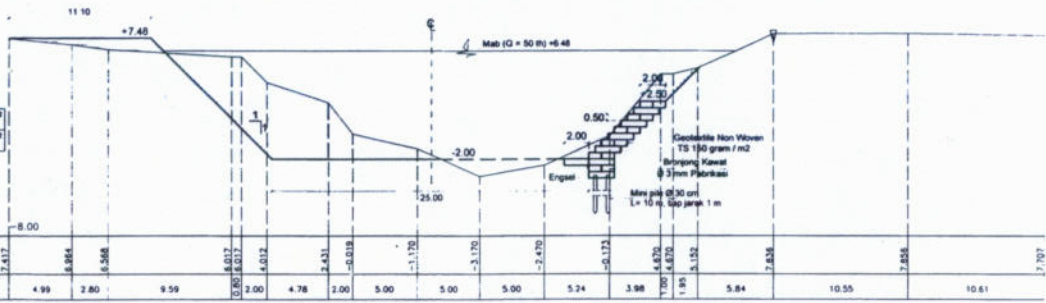

P.13+150

Gal.tanah 121.30 M³
Timb.tanah M³

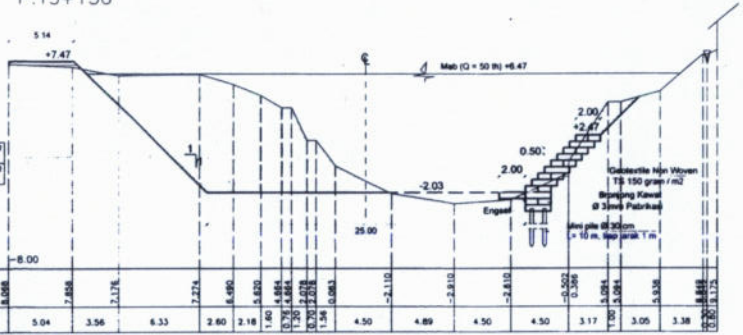

HI.40

Gal.tanah 154.47 M³
Timb.tanah M³

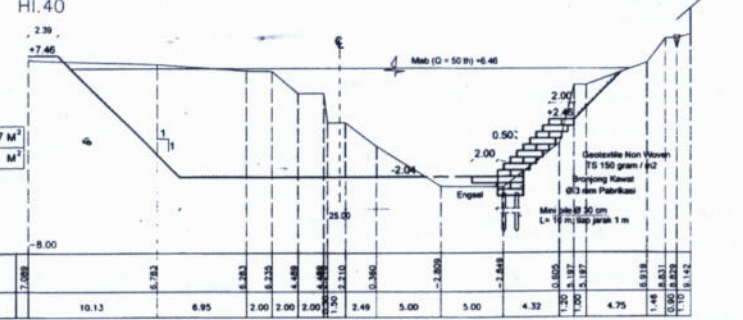

HI.50



PEMERINTAH PROVINSI JAWA TENGAH DINAS PEKERJAAN UMUM SUMBER DAYA AIR DAN PENATAAN RUANG <small>J. KHUANGHONG BLOK 10-BB TEL. P. (021) 520001 TERANG, JEMBER P. 101200 BEKAMPANG KODE POS 50141</small>		SERVIS SURVEI INVESTIGASI DAN DESAIN BIDANG PERENCANAAN DAN BENTUK
GAMBAR POTONGAN MELINTANG SUNGAI KUPANG HI.20 - HI.50		PEKERJAAN DD SUNGAI KUPANG, SUNGAI BAKSER C1 KABUPATEN PESAWARAN (PANEL P - 22)
NO. REGISTER 01-02-07-23		NO. JAW. LEMBAR 23 / 204
DIREKTUR KETUA TM BUDI SANTOSA, MT		NO. KONTRAK
DIREKTOR KASI BID. Y. SUMKINDO, MT RABDI PPT Y. LUKITO, Sp 1		NO. MESI 2016
OLEH DRENC. DIBET		NO. 14 / 2019

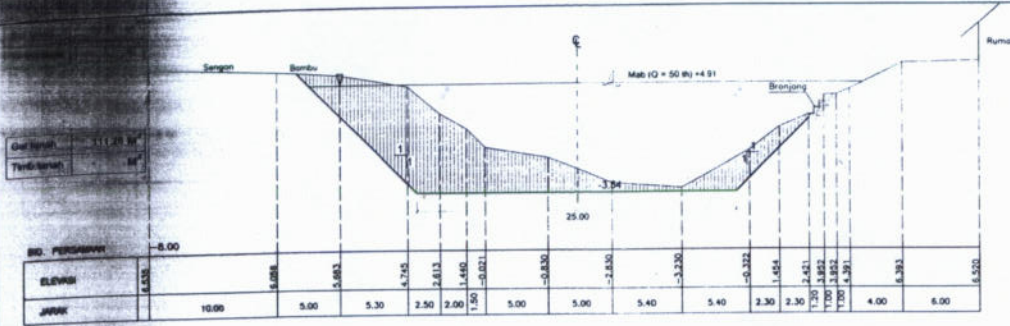

P.11+400

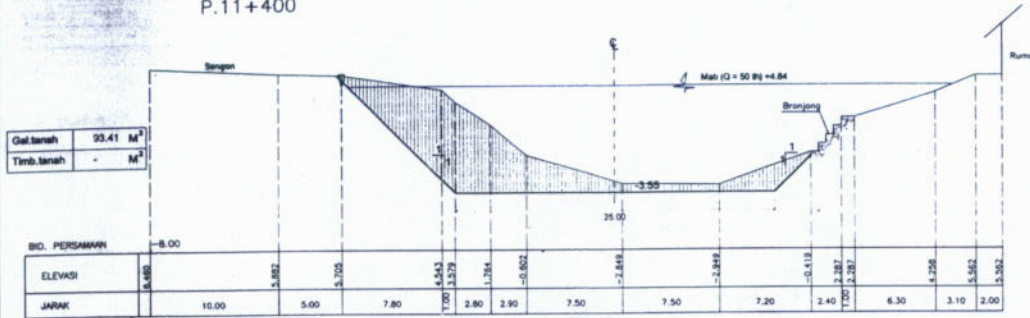

P.11+350

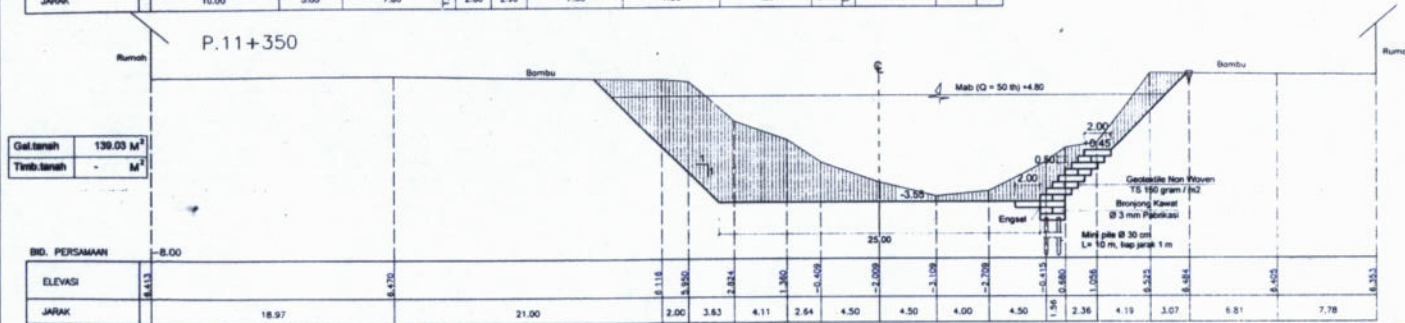

CP.04

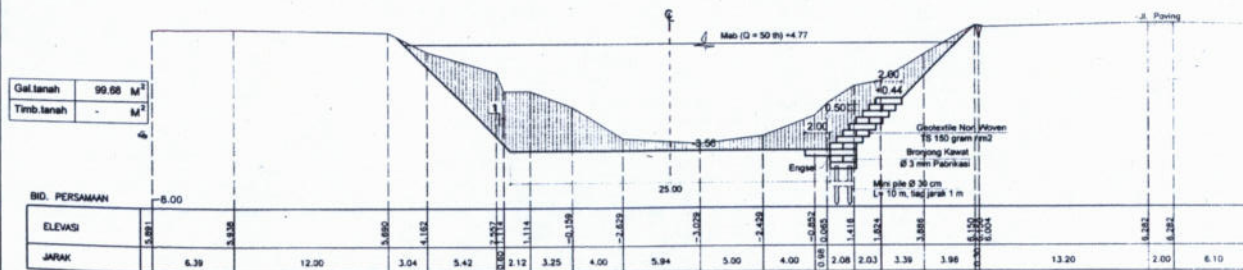

A.20



	PEMERINTAH PROVINSI JAWA TENGAH DINAS PERENCANAAN SUMBER DAYA AIR DAN PENALTAAN RUMAH A. KHORRIDI RUKA ALABI TELP. (021) 750321. TERAS. TAMBAH PUL. TERAS SEMARANG (KODE POS: 50144)		SEKSI SURVEI, INVESTIGASI DAN DESAIN BIDANG PENGEMBANGAN DAN BUKET
	GAMBAR POTONGAN MELINTANG SUNGAI KUPANG P.11+400 - A.20		PEKERJAAN 00 BUNDAH KUPANG, SUNGAI BANDER 08 KABUPATEN PEKALONGAN (PANGKAT P-20)
	NO. REGISTER : 01-02-07-08 NO. JAL. LEMBAR : 04 / 204		KABUPATEN : PEKALONGAN TANGGAL : NOMOR KONTRAK :
	DIREKSI / KASUBID : B. BUNGAH, MT KASUBID PPT : K. LUKITO, Sp.1		08 MEI 2018

Gal. tanah	98.22 M ²
Timb. tanah	- M ²

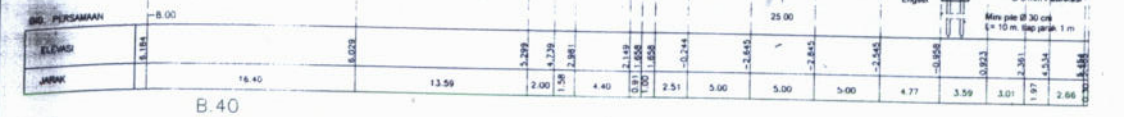

B.40

Gal. tanah	120.87 M ²
Timb. tanah	- M ²



C.60

Gal. tanah	94.16 M ²
Timb. tanah	- M ²

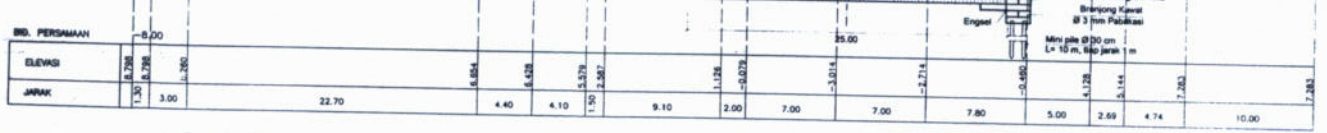

P.11+200

Gal. tanah	101.56 M ²
Timb. tanah	- M ²

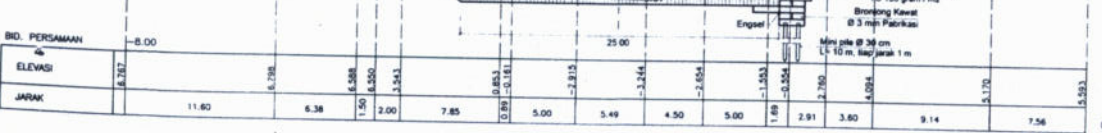

D.80

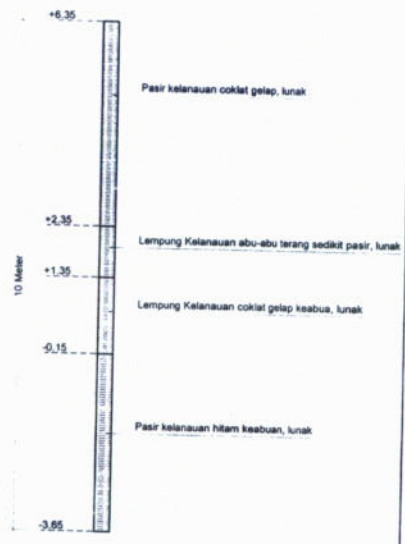

DETAIL BM.1
C.60

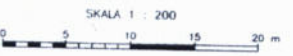

<p>PEMERINTAH PROVINSI JAWA TENGAH DINAS PEKERJAAN UMUM SUMBER DAYA AIR DAN PENATAAN RUANG J. WARDIHOLOK KAWAN TELP. (0343) 700021; 700022; 700023; 700024 FAX: 7010304 BIMARANGLI (KORAN) KEMAS PUS. 301411</p>		<p>BEKIS SURVEY, INVESTIGASI DAN DESAIN BERANG PENGEMBANGAN DAN BINTEK</p>
<p>GAMBAR : POTONGAN MELINTANG SUNGAI KUPANG B.40 - D.80</p>		<p>PEKERJAAN DD BUNGA KUPANG, BUNGA BANGKOR GS KABUPATEN PEKALONGAN INVEST P-20</p>
<p>NO. REGISTER 01-02-07-36</p>		<p>NO. JML. LEMBAR 38 / 254</p>
<p>DIREKTUR: FIKERUS TALUK ARBAR, ST KETUA TIM: P. BUDI SANTOSA, MT</p>		<p>TANGGAL: 08 MEI 2018</p>
<p>DIREKSI / KASIB / B. BANGKONG, MT</p>		<p>NOMOR KONTRAK: 014 / 2018</p>

NO	TGL	YANG DINEVSI	OLEH	DIREKSI	DIBET.

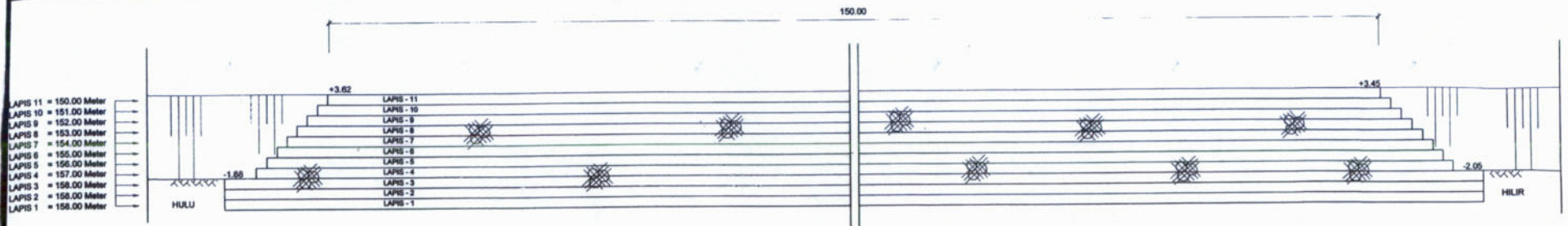

DENAH PEMASANGAN BRONJONG KANAN

SKALA 1 : 100

- LAPIS 11 = 150.00 Meter
- LAPIS 10 = 151.00 Meter
- LAPIS 9 = 152.00 Meter
- LAPIS 8 = 153.00 Meter
- LAPIS 7 = 154.00 Meter
- LAPIS 6 = 155.00 Meter
- LAPIS 5 = 156.00 Meter
- LAPIS 4 = 157.00 Meter
- LAPIS 3 = 158.00 Meter
- LAPIS 2 = 158.00 Meter
- LAPIS 1 = 159.00 Meter

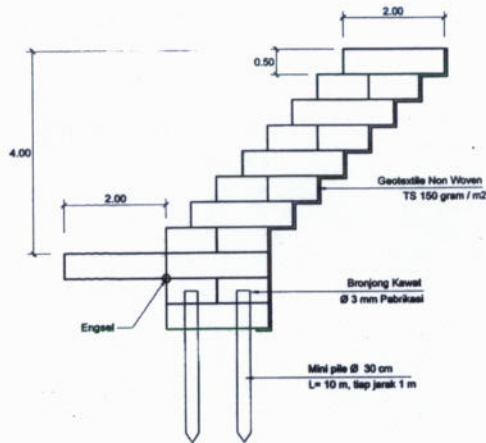

DETAIL BRONJONG KANAN

SKALA 1 : 50

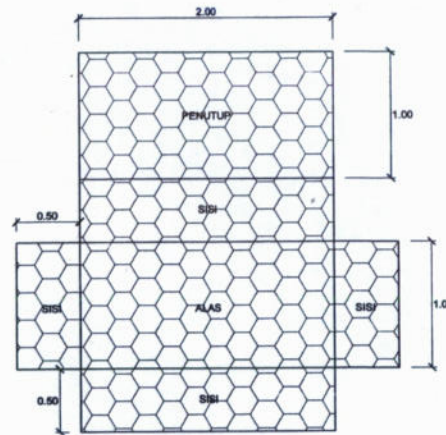

BUKAAN BRONJONG

SKALA 1 : 20

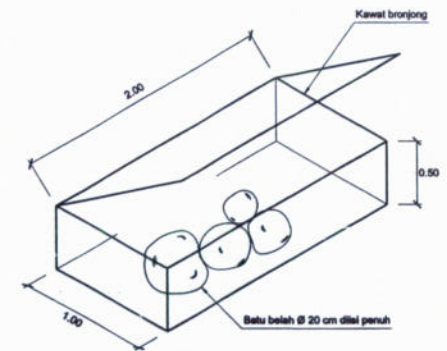

DETAIL KONSTRUKSI BRONJONG

SKALA 1 : 20

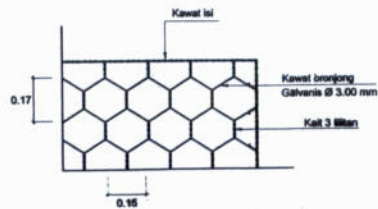

DETAIL ANYAMAN BRONJONG

SKALA 1 : 10

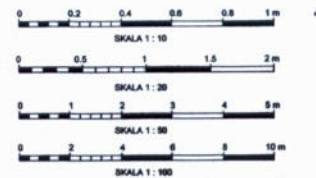

<p>PEMERINTAH PROVINSI JAWA TENGAH DINAS PERENCANAAN, BUDIDAYA, PERTANIAN DAN PERUMAHAN RUMAH SAKIT A. SURABAYA BUKITI A.44-88 TELP. (021) 792211, 792212, 792213 FAX: 791228 BIDANG PERENCANAAN (KORIDOR P.014)</p>		KEGIATAN BAWA: BANGUNAN DAN DESAIN BERSAMA PERENCANAAN DAN BINA	
		NO. JAM. LEMBAR : 130 / 304	
GAMBAR : Detail Rencana Bronjong Kanan Kuripan Kidul Gang 25 - Gang 24 P.13+250 - 14.80		NO. JAM. LEMBAR : 130 / 304	
DIREKTUR : S. BUDI BAHOTUA, ST		TANGGAL : 06 MEI 2018	
DESAIN / KAMI : S. LANTO, Sp.1		NO. KONTAK : 014 / 2018	

NO.	TGL.	YANG DIBEKAS	OLEH	DIBENI	DISET.